

# TC22 and TC27 Accessories Guide

The ultimate cost-effective  
tool for small businesses —  
with big business features

Revised June 2024

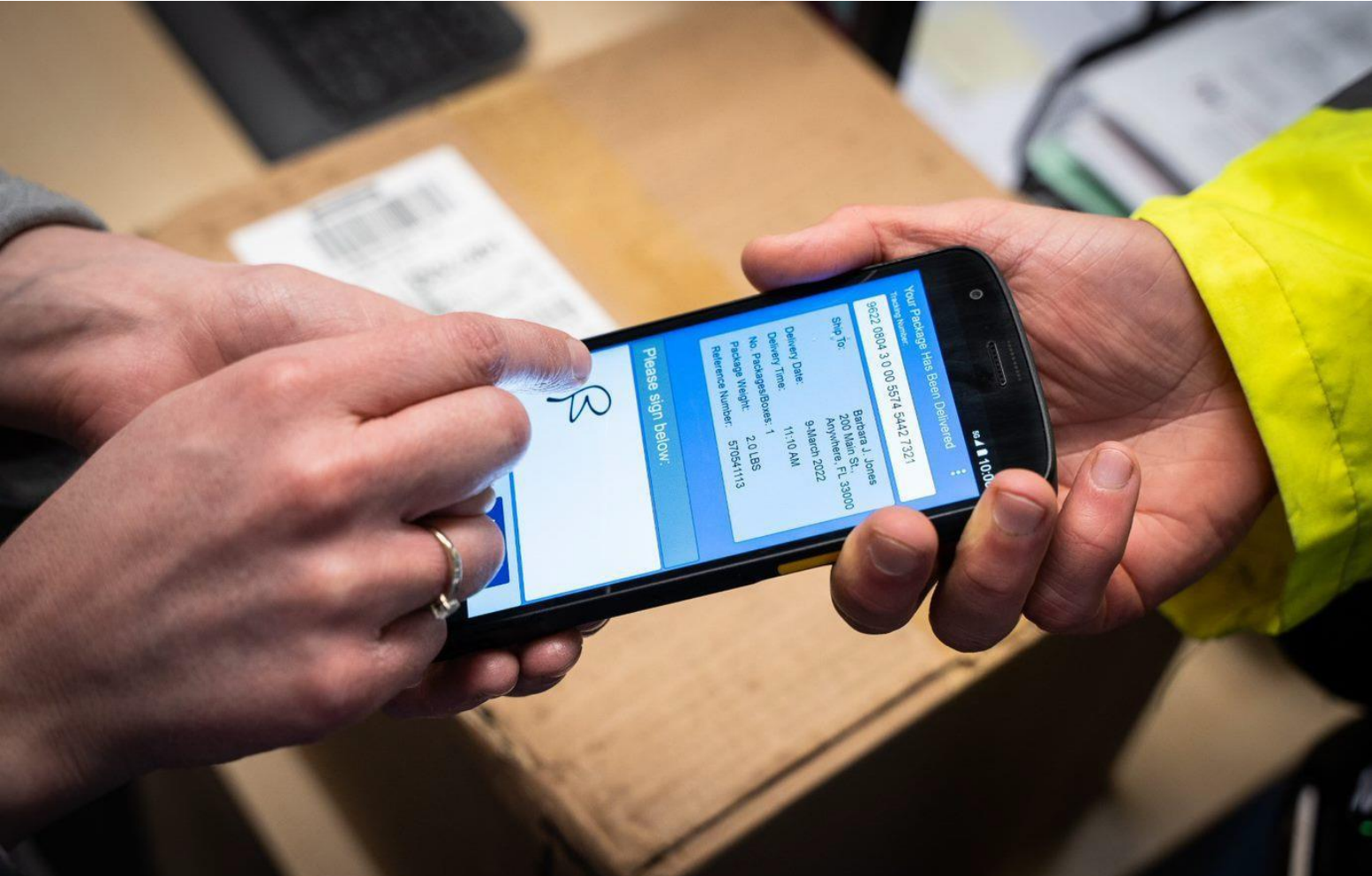

<b>I.</b>	<b>Accessories that POWER devices</b>	
<b>1</b>	<b>Cradles</b>	
1.1	<a href="#">Single-slot cradles</a>	3
1.2	<a href="#">Multi-slot cradles</a>	4
1.3	<a href="#">Cradle cups</a>	5
1.4	<a href="#">Mounting options for chargers</a>	6
<b>2</b>	<b>Batteries</b>	
2.1	<a href="#">Spare Li-on Bluetooth batteries</a>	7
2.2	<a href="#">Spare Li-ion batteries</a>	7
2.3	<a href="#">Spare battery chargers</a>	8
<b>3</b>	<b>Power supply, cables, and adapters</b>	
3.1	<a href="#">Power supply and cable matrix</a>	9
3.2	<a href="#">Country-specific AC line cords</a>	10
<b>II.</b>	<b>Accessories that ENABLE productivity solutions</b>	
<b>4</b>	<b>Headsets</b>	
4.1	<a href="#">Wired headsets and accessories for Workforce Connect</a>	12
4.2	<a href="#">Wired headsets and accessories for voice-directed picking</a>	13
4.3	<a href="#">Wireless headsets and accessories for voice-directed picking</a>	13
4.4	<a href="#">Cables and adaptors</a>	14
<b>5</b>	<b>Wearable mounts and other accessories</b>	
5.1	<a href="#">Arm / wrist mounts</a>	15
5.2	<a href="#">Replacement straps and arm sleeves</a>	16
5.3	<a href="#">Replacement straps, hand strap, and comfort pad</a>	17
<b>6</b>	<b>Trigger handles</b>	
6.1	<a href="#">Electronic Trigger Handle</a>	18
<b>III.</b>	<b>Accessories that PROTECT devices</b>	
<b>8</b>	<b>Soft holsters, rugged boots, and screen protectors</b>	
8.1	<a href="#">Soft holsters, rugged boots, and screen protectors</a>	19
<b>9</b>	<b>Third Party Accessories for TC22/27</b>	
9.1	<a href="#">3<sup>rd</sup> Party Accessories for TC22 / 27</a>	21

# Accessories that power devices



## Single-slot cradles



### Single-slot charger cradle

**SKU# CRD-TC2L-BS1CO-01**

Single-slot charge-only cradle for one TC22 / TC27 device.

- Charges standard capacity battery from 0 to 80% in less than 2 hours 20 minutes.
- Charges extended capacity battery from 0 to 80% in less than 3 hours 10 minutes.
- Compatible with TC22 / TC27 units with hand straps, trigger handle or protective boot when shim is removed.
- Sold separately: Single-slot cradle requires power supply **SKU# PWR-WUA5V12W0XX** (last XX of SKU are country-specific) and USB-C cable **SKU# CBL-TC5X-USBC2A-01**.



### Single-slot USB / Ethernet charger cradle

**SKU# CRD-TC2L-SE1ET-01**

Single-slot charger and USB cradle. Charges a single device.

- Charges standard capacity battery from 0 to 80% in less than 1 hours 20 minutes.
- Charges extended capacity battery from 0 to 80% in less than 1 hours 50 minutes.
- Compatible with TC22 / TC27 units with hand straps, trigger handle or protective boot when shim is removed.
- Sold separately: Power supply **SKU# PWR-BGA12V50W0WW**, DC cable **SKU# CBL-DC-388A1-01**, and country-specific AC line cord (listed later in this document). To charge and sync using USB port with a computer, purchase USB cable **SKU# 25-124330-01R**. To connect to Ethernet, purchase USB-to-Ethernet module **SKU# MOD-MT2-EU1-01** with bracket **SKU# BRKT-TC51-ENET1-02**.



### Single-slot device and battery charger cradle

**SKU# CRD-TC2L-BS11B-01**

Single-slot charger charges a TC22 / TC27 device and its spare Li-Ion battery.

- Charges Standard battery in device from 0 to 80% in less than 1 hour 20 minutes.
- Charges Extended battery in device from 0 to 80% in less than 1 hour 50 minutes.
- Compatible with TC22 / TC27 units with hand strap, trigger handle, or protective boot when shim is removed.
- Sold separately: Power supply **SKU# PWR-BGA12V50W0WW**, DC cable **SKU# CBL-DC-388A1-01**, and country-specific AC line cord (listed later in this document).



# Accessories that power devices



## Multi-slot cradles

### Five-slot charger cradle

**SKU# CRD-TC2L-BS5CO-01**

Multi-slot cradle to charge up to five TC22 / TC27 devices.

- Charges Standard Capacity battery from 0 to 80% in less than 1 hour 20 minutes.
- Charges Extended Capacity battery from 0 to 80% in less than 1 hour 50 minutes.
- Compatible with TC22 / TC27 units with hand straps, trigger handle, or protective boot when shim is removed.
- Can be rack-mounted in a standard 19-inch server rack via mounting bracket **SKU# BRKT-SCRD-SMRK-01**.
- Sold separately: Power supply **SKU# PWR-BGA12V108W0WW**, DC cable **SKU# CBL-DC-381A1-01**, and country-specific AC line cord (listed later in this document).



### Five-slot charge / Ethernet cradle

**SKU# CRD-TC2L-SE5ET-01**

Five-slot charge / Ethernet cradle. Charges five devices with network speeds of up to 1Gbps.

- Charges Standard Capacity battery from 0 to 80% in less than 1 hour 20 minutes.
- Charges Extended Capacity battery from 0 to 80% in less than 1 hour 50 minutes.
- Compatible with TC22 / TC27 units with hand straps, trigger handle, or protective boot when shim is removed.
- Can be rack-mounted in a standard 19-inch server rack via mounting bracket **SKU# BRKT-SCRD-SMRK-01**.
- Sold separately: Power supply **SKU# PWR-BGA12V108W0WW**, DC cable **SKU# CBL-DC-381A1-01**, and country-specific AC line cord (listed later in this document).



# Accessories that power devices

## Cradle cups

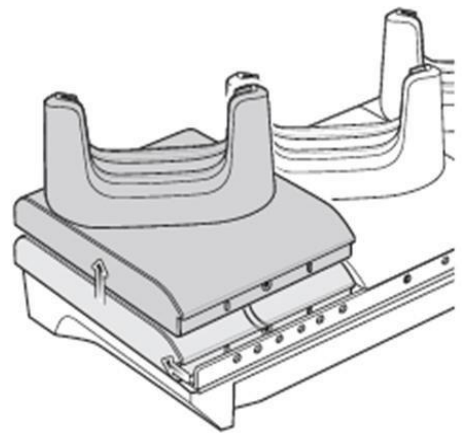

### Device cradle cup replacement kit

**SKU# CRDCUP-TC2L1C-01**

One TC22 / TC27 device cradle cup replacement kit. Can be used to replace another device's cup purchased after 2019 on ShareCradle when upgrading to TC22 / TC27.

- Also available as a 5-pack — 5 device cradle cups — **SKU# CRDCUP-TC2L5C-01**.
- Not all five cups need to be used, therefore creating a multi-slot cradle supporting a mixed combination of devices (e.g., two TC22 / TC27 and three TC5X devices).

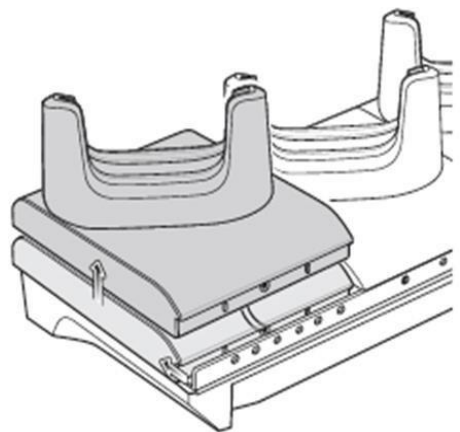

### Charge and communication device cradle cup replacement kit

**SKU# CRDCUP-TC2L1E-01**

One TC22 / TC27 charge and USB / Ethernet connection device cradle cup replacement kit. Can be used to replace another device's cup purchased after 2019 on ShareCradle when upgrading to TC22 / TC27.

- Also available as a 5-pack — 5 device cradle cups — **SKU# CRDCUP-TC2L5C-01**.
- Not all five cups need to be used, therefore creating a multi-slot cradle supporting a mixed combination of devices (e.g., two TC22 / TC27 and three TC5X devices).

# Accessories that power devices

## Mounting options for chargers



### Rack mounting for space optimization

Optimize available space by mounting any set of five-slot chargers for TC22 / TC27 on a standard, 19-inch server rack.

- Ideal for customers that have several devices per location.
- Compatible with all five-slot chargers for TC22 / TC27.

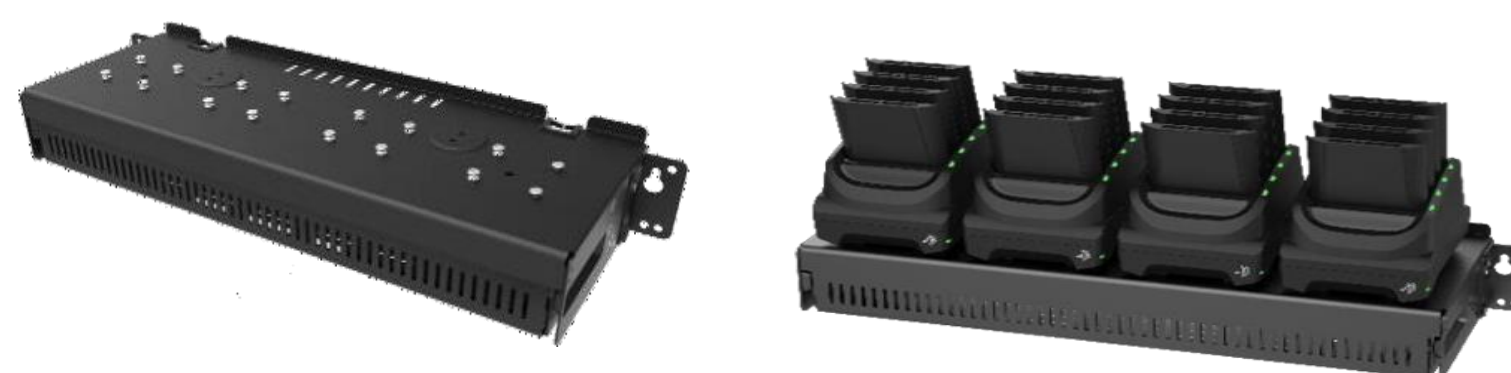

### Mounting bracket

#### SKU# BRKT-SCRD-SMRK-01

Use five-slot ShareCradle mounting bracket to attach five-slot TC22 / TC27 cradles to the wall or mount on a 19-inch server rack.

- Offers cable routing slots and removable tray that stores / conceals power supply.
- Adjustable orientations:
  - 25° angle for high-density (five-slot chargers).
  - Horizontal (single-slot or four-slot spare Li-ion charger).
- Four 4-slot spare battery chargers can be mounted as shown with mounting bracket.
- Use to mount to wall or with standard 19-inch server rack for more density and save space.

# Accessories that power devices



## Spare Li-on batteries

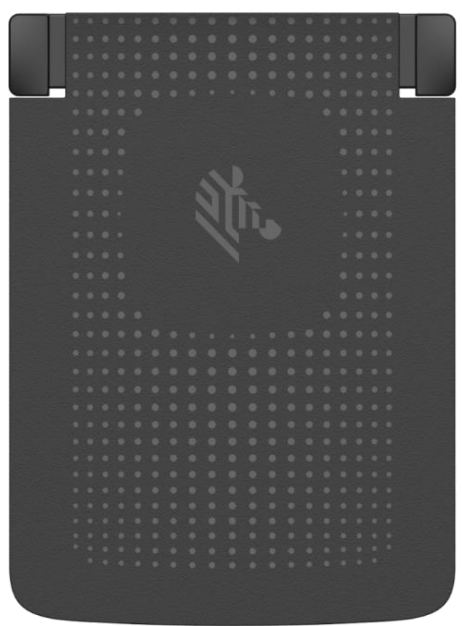

### Standard Li-ion Bluetooth Battery with PowerPrecision SKU# BTRY-TC2L-2XMAXB-01

Standard capacity 3,800mAh PowerPrecision Li-Ion Battery with BLE Beacon.

- Premium-grade battery cells with longer lifecycle and tested to meet rigorous controls and standards.
- BLE beacon allows device with this battery to be located even if powered off using [Zebra Device Tracker](#).
- Sold separately: Zebra Device Tracker licenses for either 1-year SKU# SW-BLE-DT-SP- 1YR or 3-years SKU# SW-BLE-DT-SP-3YR.

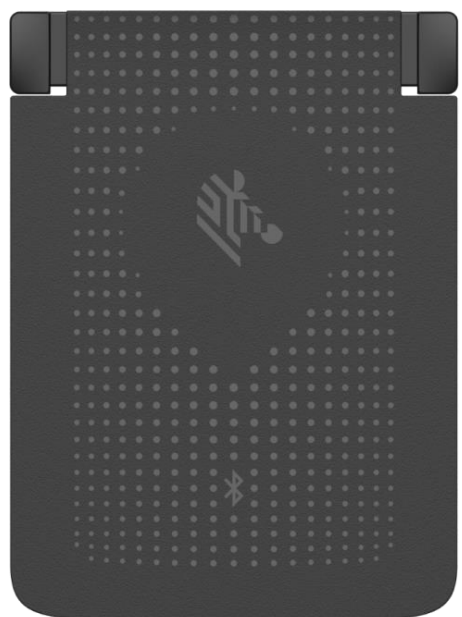

### Standard Li-ion Battery with PowerPrecision SKU# BTRY-TC2L-2XMAXX-01

Standard capacity 3,800 mAh PowerPrecision Li-ion Battery.

- Premium-grade battery cells with longer lifecycle and tested to meet rigorous controls and standards.



### Extended PowerPrecision Li-ion Battery SKU# BTRY-TC2L-3XMAXX-01

Extended capacity 5,200 mAh PowerPrecision Li-ion battery.

- Premium-grade battery cells with longer lifecycle and tested to meet rigorous controls and standards.

## Accessories that power devices

### Spare battery chargers



#### Battery Charger

##### SKU# SAC-TC2L-4SCHG-01

Spare battery charger to charge any four Li-ion batteries.

- Charges Standard Capacity battery from 0 to 90% in less than 3 hours.
- Charges Extended Capacity battery from 0 to 90% in less than 4 hours..
- Can be used standalone or up to 4 chargers can be mounted on Mounting Bracket [SKU# BRKT-SCRD-SMRK-01](#).
- Sold separately: Power Supply [SKU# PWR-BGA12V50W0WW](#), DC Cable [SKU# CBL-DC-388A1-01](#), and Country-specific AC Line cord (listed later in this document).



#### Battery charger replacement kit

##### SKU# CRDCUP-TC2L4B-01

Four-slot battery charger replacement cup.

- Used to replace a legacy TC21 / TC26 series 4-slot Battery Charger on single-slot or multi-slot ShareCradle base when migrating from TC21 / TC26 to TC22 / TC27.
- No more than one cup shall be installed on a multi-slot ShareCradle base when converting with this 4-slot Battery Charger cup.
- Should replace the TC21/TC26 toaster cup in the same location on the ShareCradle base, usually the left-most slot when facing the cradle.

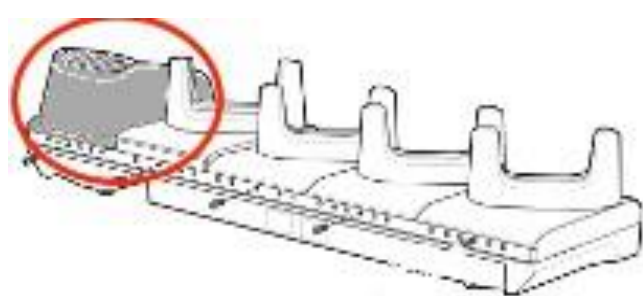



# Accessories that power devices















## Power supply, cables, and adapters

SKU#	Description	Note
<a href="#">PWR-BGA12V108W0WW</a>	Level VI AC/DC power supply brick. AC Input: 100-240V, 2.8A. DC Output: 12V, 9A, 108W.	<b>Sold separately.</b> Use for: <ul style="list-style-type: none"> <li>• CRD-TC2L-BS5CO-01</li> <li>• CRD-TC2L-SE5ET-01</li> </ul>
<a href="#">CBL-DC-381A1-01</a>	DC line cord for running multi-slot cradles from a single Level VI power supply.	
<a href="#">PWR-BGA24V150W1WW</a>	Level VI power supply brick. Used to power five-slot sharecradles.	
<a href="#">PWR-BGA12V50W0WW</a>	Level VI AC/DC power supply brick. AC Input: 100-240V, 2.4A. DC Output: 12V, 4.16A, 50W.	<b>Sold separately.</b> Use for: <ul style="list-style-type: none"> <li>• CRD-TC2L-SE1ET-01</li> <li>• CRD-TC2L-BS11B-01</li> <li>• SAC-TC2L-4SCHG-01</li> </ul>
<a href="#">CBL-DC-388A1-01</a>	DC line cord for running single-slot cradles or battery chargers from a single Level VI power supply.	
<a href="#">CBL-TC2X-USBC-01</a>	USB-A to USB-C cable with an additional ferrite bead.	
<a href="#">KIT-PWR-12V50W</a>	Power supply kit for single-slot cradle including Power Supply <a href="#">SKU# PWR-BGA12V50W0WW</a> and DC line cord <a href="#">SKU# CBL-DC-388A1-01</a> .	<b>Sold separately:</b> Country-specific AC line cord.
<a href="#">CBL-DC-382A1-01</a>	DC line cord for running five-slot cradles when using Level VI Efficiency power supply <a href="#">SKU# PWR-BGA12V108W0WW</a> . Includes black extension tab for releasing the cable.	
<a href="#">CBL-TC5X-USBC2A-01</a>	USB C to USB A communications and charging cable, 1m long	<b>Sold separately.</b> Use to: <ul style="list-style-type: none"> <li>• Directly charge TC22 / TC27 using a wall wart</li> <li>• Connect TC22 / TC27 to a computer (developer tools)</li> <li>• Charge TC22 / TC27 in a vehicle (can be used with cigarette light adapter <a href="#">SKU# CHG-AUTO-USB1-01</a>, if needed)</li> </ul>
<a href="#">CBL-TC2Y-USBC90A-01</a>	USB C to USB A cable with 90° bend in USB-C adapter	
<a href="#">25-124330-01R</a>	Micro USB active-sync cable for use with Single Slot USB/Communication Cradle.	<b>Sold separately.</b> Required for use with <a href="#">SKU# CRD-TC2L-SE1ET-01</a> if syncing with a computer is desired while TC22 / TC27 is in the charger.
<a href="#">CBL-DC-523A1-01</a>	DC Y-line cord for running two 4-slot battery chargers to a single Level VI power supply <a href="#">SKU# PWR-BGA12V108W0WW</a> .	<b>Sold separately. Use to:</b> Consolidate power supplies for multiple spare battery chargers proximally placed to each other.
<a href="#">PWR-WUA5V12W0XX</a>	USB type A power supply adaptor (wall wart). Replace 'XX' in SKU as follows to get the right plug style based on region:  <b>US</b> (United States) • <b>GB</b> (United Kingdom) • <b>EU</b> (European Union) <b>AU</b> (Australia) • <b>CN</b> (China) • <b>IN</b> (India) • <b>KR</b> (Korea) • <b>BR</b> (Brazil)	<b>Sold separately.</b> Use with a communications & charge cable to directly charge TC22 / TC27 device drawing power from a wall socket.

[Back to Table of Contents](#)

## Power supply, cables, and adaptors

### Country-specific AC line cords: grounded, 3-prong

SKU#	Country / region	Note	
<a href="#">23844-00-00R</a>	North America (United States, Canada, Mexico)	7.5 feet long Commonly used with chargers mounted in server racks	
<a href="#">50-16000-678R</a>	North America (United States, Canada, Mexico)	3 feet long	
<a href="#">50-16000-221R</a>	North America (United States, Canada, Mexico)	6 feet long	
<a href="#">50-16000-727R</a>	Brazil	1.8 meters (6 feet) long	
<a href="#">50-16000-680R</a>	Argentina	1.8 meters (6 feet) long	
<a href="#">50-16000-217R</a>	American Samoa, Australia, New Guinea	1.8 meters (6 feet) long	
<a href="#">50-16000-218R</a>	Japan	1.8 meters (6 feet) long	
<a href="#">50-16000-219R</a>	Antigua, Bermuda, Burma, Channel Islands, Hong Kong, Iraq, Ireland, Malaysia, North Ireland, Scotland, Singapore, United Kingdom, Wales	1.8 meters (6 feet) long	
<a href="#">50-16000-257R</a>	China	1.8 meters (6 feet) long	
<a href="#">50-16000-220R</a>	Europe, Abu Dhabi, Bolivia, Dubai, Egypt, Iran, Korea, Russia, Vietnam	1.8 meters (6 feet) long	
<a href="#">50-16000-671R</a>	Italy	1.8 meters (6 feet) long	
<a href="#">50-16000-669R</a>	India, S. Africa, Africa	1.8 meters (6 feet) long	

# Accessories that power devices



## Power supply, cables, and adaptors

### Country-specific AC line cords: ungrounded, 2-prong

SKU#	Country / region	Note
<a href="#">50-16000-182R</a>	United States	Type A NEMA 1-15 plug
<a href="#">50-16000-255R</a>	Europe, Abu Dhabi, Bolivia, Dubai, Egypt, Iran, Korea, Russia, Vietnam.	Type C CEE7/16 plug
<a href="#">50-16000-670R</a>	Bermuda, Hong Kong, Iraq, Ireland, Malaysia, Singapore, United Kingdom.	



# Accessories that enable productivity solutions

## Headsets



### Close gaps, Open possibilities with Workforce Connect

Usher in a new era of transformation—one led by your frontline and powered by Zebra Workforce Connect. One where communication and information flows freely and gaps between teams, workflows and data are closed.

With Workforce Connect, hindered workers become effective problem solvers, contributing their best. Critical workflows are streamlined in one place, on one device, equipping workers with the information they need, right at their fingertips.

Only Zebra offers the most complete lineup of software and rugged hardware with the scalability, support and service needed to make the greatest impact where it counts—on the frontline.

[Learn more about you can elevate your frontline workers with Zebra Workforce Connect.](#)



### Wired headsets for Workforce Connect

#### SKU# HDST-USBC-PTT1-01

**PTT headset with USB-C connector; one-piece solution.**

- **For Push-To-Talk (PTT) applications with volume up/volume down/PTT buttons. Compatible with PTT Express/PTT Pro.**
- **Rotating earpiece allows for right or left ear configuration. Mono headset with microphone.**
- **Includes clip for attaching PTT button to clothing.**



### Wired headsets for Workforce Connect

#### SKU# HDST-35MM-PTVP-02

**PTT and VoIP headset with 3.5mm standard jack.**

- **For Push-To-Talk (PTT) and VoIP telephony. Compatible with PTT Express/PTT Pro.**
- **Rotating earpiece allows for right or left ear configuration. Mono headset with microphone.**
- **Includes clip for attaching PTT button to clothing.**
- **Requires adapter [SKU# ADP-USBC-35MM1-01](#).**

# Accessories that enable productivity solutions

## Headsets



Rugged Bluetooth and corded HD voice headsets for the most demanding industrial environments

When it comes to enabling speech-driven applications and voice communications in warehouses, manufacturing plants and outdoor yards, you need a headset that is specially designed for the job. The HS3100 Bluetooth and HS2100 corded headsets are loaded with features that offer everything you need in an industrial headset.

[Learn more about how these headsets deliver a superior voice experience.](#)

### Wired headsets for voice-directed picking

#### HS2100 rugged wired headset

**Corded HD voice headset. Can be used with TC22/TC27 devices with adapters **SKU# CBL-HS2100-3MS1-01** and **SKU# ADP-USBC-35MM1-01**.**

- **Dustproof, spray proof, and waterproof.**
- **Noise cancellation for a superior voice experience in the noisiest environments.**
- **Swiveling boom mutes microphone allowing user to prevent voice pick applications from recognizing non-voice pick conversations.**



SKU#	Description
<a href="#">HS2100-OTH</a>	HS2100 Rugged Wired Headset Over-The-Head Headband includes HS2100 Boom Module and HSX100 OTH Headband Module
<a href="#">HS2100-BTN-L</a>	HS2100 Rugged Wired Headset (Behind-the-neck headband left)
<a href="#">HS2100-OTH-SB</a>	HS2100 Rugged Wired Headset (Over-the-head headband) includes HS2100 Shortened Boom Module and HSX100 OTH headband module
<a href="#">HS2100-BTN-LSB</a>	HS2100 Rugged Wired Headset (Behind-the-neck headband left) includes HS2100 Shortened Boom Module and HSX100 BTN headband module

### Wireless headsets for voice-directed picking

#### HS3100 rugged Bluetooth headset

**Bluetooth headset for voice-directed picking applications.**

- **Noise cancellation tuned for Voice-Directed Picking applications.**
- **Swap batteries on the fly — without losing the Bluetooth connection.**
- **Split-second tap-to-pair simplicity using NFC. 15 hours of battery power.**



SKU#	Description
<a href="#">HS3100-OTH</a>	HS3100 Bluetooth Headset Over-The-Head Headband includes HS3100 Boom Module and HSX100 OTH Headband Module
<a href="#">HS3100-BTN-L</a>	HS3100 Bluetooth Headset (Behind-the-neck headband left)
<a href="#">HS3100-OTH-SB</a>	HS3100 Bluetooth Headset (Over-the-head headband) includes HS3100 Shortened Boom Module and HSX100 OTH headband module
<a href="#">HS3100-BTN-LSB</a>	HS3100 Bluetooth Headset (Behind-the-neck headband left) includes HS3100 Shortened Boom Module and HSX100 BTN headband module
<a href="#">HS3100-SBOOM-01</a>	HS3100 Shortened Boom Module (includes microphone boom, battery and windscreen)

[Back to Table of Contents](#)

# Accessories that enable productivity solutions

## Cables and adapters



### USB

**SKU# 25-124330-01R**

Single slot cradle to PC / host USB cable.

- Used with single-slot cradle.
- Micro-USB connection on cradle end.
- Cable length is 48 inches.



### HS2100 Standard cable

**SKU# CBL-HS2100-3MS1-01**

HS2100 headset standard cable – 3.5mm jack.

- 3.5mm barrel jack connector with cable length 43 inches or 1.1 meters.
- For use with TC22 / TC27 or other devices using a 3.5mm barrel jack audio connector. Requires **SKU# ADP-USBC-35MM1-01**.
- Rugged cable with rugged connectors that are keyed / collared for a locking failsafe connection.
- Includes one clothing clip. Additional clips can be purchased separately.



### Adapter cable

**SKU# ADP-USBC-35MM1-01**

USB-C to 3.5mm adapter cable.

- Allows headsets with 3.5mm jack to be connected to TC22/TC27.
- Adapter provides push-to-talk (PTT) button, volume up / down buttons.
- Adapter cable length is about 2.5 feet or 78 centimeters.
- Clip on rear of adapter allows cable to be wrapped for length management
- PTT button functionality tested with headset **SKU# HDST-35MM-PTVP- 02** where both the PTT button the headset and the adapter may be used.



## Arm / wrist mounts



### Arm mount with medium size length strap

#### SKU# SG-TC2L-ARMNT-01

Arm mount with medium size length strap.

- Enables the TC22 / TC27 to be mounted to the arm for hands free operation and can be used with the RS5100 / RS6100 (or similar) ring scanner.
- Compatible with Standard or Extended Capacity battery.
- Not compatible with Rugged Boot.
- Includes: Medium length (30cm or 12 inches) Velcro wrist strap [SKU# SG-TC2L-ARMSTRAP-01](#) and carrier comfort pad [SKU# SG-TC2L-CMPD-01](#)



### Arm mount with large size length strap

#### SKU# SG-TC2L-ARMNT-02

Arm mount with large size length strap.

- Enables the TC22 / TC27 to be mounted to the arm for hands free operation and can be used with the RS5100 / RS6100 (or similar) ring scanner.
- Compatible with Standard or Extended Capacity battery.
- Not compatible with Rugged Boot.
- Includes: Large sized (33cm or 13 inches) Velcro wrist strap [SKU# SG-TC2L-ARMSTRAP-02](#) and carrier comfort pad [SKU# SG-TC2L-CMPD-01](#)



### Arm mount with extended length strap

#### SKU# SG-TC2L-WMADP1-02

- Wrist mount with extended BOA dial-to-fit wrist strap
- Swivel design allows device to be viewed in portrait or landscape mode enabling hands- free functionality.
- Velcro-free design uses non-absorbent materials that can be wiped down.
- Strap length can be adjusted between 164 to 265mm (approx. 6.5 to 10.5")
- Not compatible with Rugged Boot.
- Includes: Carrier, Comfort Pad [SKU# SG-TC2L-CMPD-01](#) and medium / large sized wrist strap [SKU# SG-NGWT-WSTPLN-01](#)

# Accessories that enable productivity solutions

## Replacement straps and arm sleeve



### BOA Replacement wrist strap

**SKU# SG-NGWT-WSTPST-01**

Replacement wrist strap – standard size.

- White dial and accent color on strap identify size as standard (small / medium).
- Strap length can be adjusted between 128 to 191mm (approx. 5.0 to 7.5").



### BOA Replacement wrist strap

**SKU# SG-NGWT-WSTPLN-01**

Replacement wrist strap – extended size.

- Black dial and accent color on strap identify size as extended (medium / large).
- Strap length can be adjusted between 164 to 265mm (approx. 6.5 to 10.5").



### BOA Replacement wrist strap

**SKU# SG-NGWT-WSTPXL-01**

Replacement wrist strap – extra-large size.

- Blue dial and accent color on strap identify size as extra-large.
- Strap length can be adjusted between 218 to 375 mm (approx. 8.5 to 14.75").



### Arm sleeve

**SKU# SG-WT4027050-01R**

Arm sleeve – pack of 5.

- Worn under wrist mount strap if worker is in short-sleeved shirt and wants extra sweat wicking / personal layer, comfort and slip-resistance
- Material will not snag. One size fits all.
- Washable in mild detergent. Should be air dried.



# Accessories that enable productivity solutions



## Replacement straps, hand strap, and comfort pad



### Velcro Replacement Strap

**SKU# SG-TC2L-ARMSTRAP-01**

Replacement arm strap – size medium.

- Replaces the Velcro strap included for **SKU# SG-TC2L-ARMNT-01**
- Comes in size large with strap length of 300mm or 12"



### Velcro Replacement Strap

**SKU# SG-TC2L-ARMSTRAP-02**

Replacement arm strap – size large.

- Replaces the Velcro strap included for **SKU# SG-TC2L-ARMNT-02**
- Comes in size large with strap length of 330mm or 13"



### Hand strap

**SKU# SG-TC2L-HSTRP1-01**

Hand strap.

- Allows device to be easily held in palm of hand.
- Attaches directly to device, even with rugged boot installed.
- Sold separately: Rugged boot **SKU# SG-TC2L-BOOT-01**.

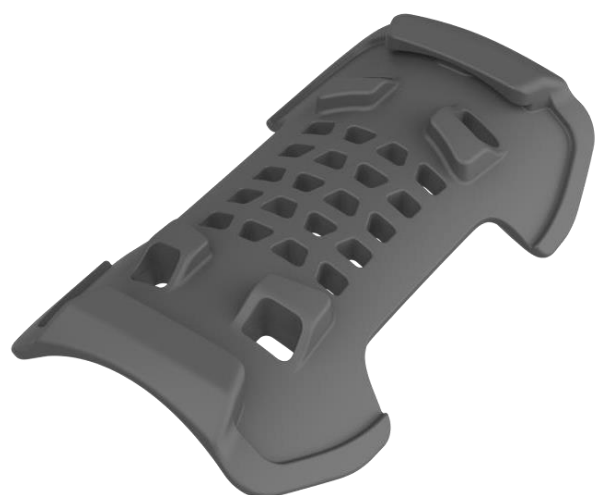

### Replacement Comfort Pad

**SKU# SG-TC2L-CMPD-01**

Comfort Pad for Arm Mount

- Replaces the Comfort Pad included on either **SKU# SG-TC2L-ARMNT-01** or **SKU# SG-TC2L-ARMNT-02** or **SKU# SG-TC2L-WMADP1-02**.
- Soft Rubber material.
- Easily removable and hygienic.

# Accessories that enable productivity solutions



## Trigger handles and accessories



### Electronic trigger handle

**SKU# TRG-TC2L-SNP1-01**

Pistol-grip trigger handle.

- Uses electrical trigger via contacts on back side of TC22 / TC27.
- Trigger handle accessory offers customers the option of using the product in a gun form factor, ideal for scan-intensive operations.
- Requires rugged boot **SKU# SG-TC2L-BOOT-01**.
- Does not block access to rear facing camera and flash allowing camera to be used while using the trigger handle.
- Compatible with both standard and extended capacity batteries.
- Not compatible with Hand Strap,



### Wrist Strap

**SKU# 50-12500-066**

- Attaches to bottom of Snap-on Trigger Handle (**SKU# TRG-TC2L-SNP1-01**).

## Soft holsters, rugged boots, and screen protectors



### Soft holster

**SKU# SG-TC2L-HLSTR1-01**

Soft holster.

- Vertical orientation with open bucket design to accommodate TC22 / TC27 with optional trigger handle **SKU# TRG-TC2L-SNP1-01**
- 
- Compatible with rugged boot **SKU# SG-TC2L-BOOT-01** and hand strap **SKU# SG-TC2L-HSTRP1-01**.
- Opening at bottom of holster for providing drainage and route for audio from device's speaker.
- Nonrotating for maximum durability.
- Compatible with devices using Standard or Extended Capacity battery.



### Rugged boot

**SKU# SG-TC2L-BOOT-01**

Rugged protective boot.

- Boot increases drop spec of device to 5 ft. (1.5 m) and drop surface to concrete.
- Compatible with devices using Standard or Extended Capacity battery.
- Compatible with Hand Strap.



### Screen protector

**SKU# SG-TC2L-SCRNPT1-01**

Screen protector.

- Tempered glass.
- Includes: Alcohol wipes, cleaning cloth, and instructions needed for screen protector installation.

## Third Party Accessories for TC22 and TC27

**Note:** Products sold that do not bear the Zebra brand name are serviced and supported exclusively by their manufacturers in accordance with terms and conditions packaged with the products. Zebra's Limited Warranty does not apply to products that are not Zebra branded, even if packaged or sold with Zebra products. Please contact the manufacturer directly for technical support and customer service.



# RAM® Form-Fit Docks

## for Zebra TC22 / TC27 Handheld Computers

Protect your investment and stay hands-free in the field with RAM® Mounts spring-loaded docking solutions for the new Zebra TC22 & TC27 handheld computers. These docks are available with and without power, as well as non-locking and key-locking functions. Powered dock options offer a seamless experience by utilizing the device's pogo pad docking contacts and USB Type-A connector — simply dock the device to keep it charging. Pair with any modular RAM® Mounts components to create a custom mounting solution for your forklift, truck, pick cart and more!



Zebra TC22 / TC27 RAM® Mounts Docks			
PART NUMBER	KEY LOCK	USB TYPE-A POWER	FOR BOOT
3PTY-RAM-HOL-ZE24U			
3PTY-RAM-HOL-ZE24LU	•		
3PTY-RAM-HOL-ZE24PU		•	
3PTY-RAM-HOL-ZE24PLU	•	•	
3PTY-RAM-HOL-ZE24-1U			•
3PTY-RAM-HOL-ZE24L-1U	•		•
3PTY-RAM-HOL-ZE24P-1U		•	•
3PTY-RAM-HOL-ZE24PL-1U	•	•	•

COMPATIBLE HARDWIRE CHARGERS

**3PTY-RAM-GDS-CHARGE-V7B1U**  
GDS® 10-30V Hardwire Charger  
w/ USB Type-A

**3PTY-RAM-GDS-CHARGE-V8BU**  
GDS® 30-64V Hardwire Charger  
w/ USB Type-A

## Product Highlights



### Pogo Pin Charging

Protect the charge port and increase efficiency utilizing the device's pogo pad docking contacts — simply dock the TC22/TC27 to keep the device charged. Each powered RAM® dock comes equipped with pogo pin technology for this seamless docking experience.



### Removable Inserts

("-1U" Part Numbers Only)

Part numbers ending in "-1U" indicate docks that include removable inserts. When installed, these inserts retain form-fit docking of the TC22/TC27 when the rugged boot is removed from the device.



### Stylus Holder

Integrated snap-in stylus holder on all docks prevent lost or dangling styluses when on-the-go.



### Mount It

With RAM® Compatibility™ customize your mount to your environment. Our recommended mount is the RAM-101U Drill-Down mount.



**Purpose-Built Mounts™**  
**For Zebra TC22/TC27**

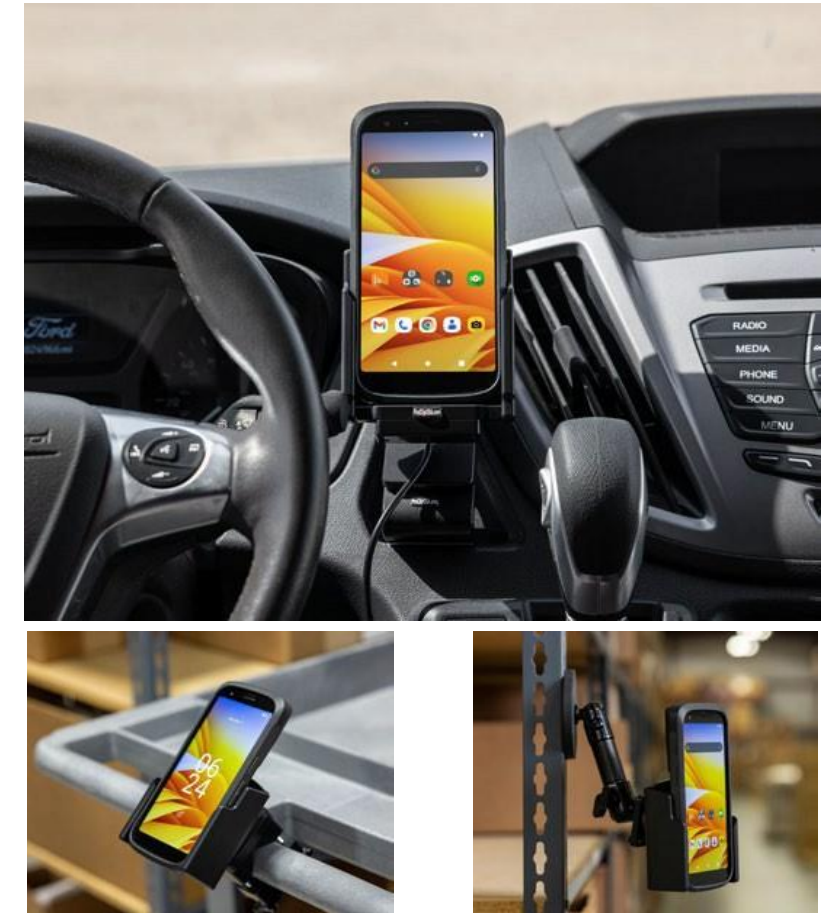

**ProClip cradles provide:**

- ✓ Easy one-handed docking and undocking
- ✓ Tilt-swivel gives users an optimized viewing angle
- ✓ Channeled sidewalls guide the device into the cradle and hold the device securely
- ✓ Heavy-duty construction provides protection and longevity
- ✓ Custom design to fit the device with or without the rugged boot



Part #	Description
3PTY-PCLIP-712348	Charging Cradle with Cigarette Lighter Plug for Zebra TC22 / TC27 with Rugged Boot
3PTY-PCLIP-712347	Charging Cradle with Cigarette Lighter Plug for Zebra TC22 / 27 (Bare Device)



Part #	Description
3PTY-PCLIP-713347	Charging Cradle with Hard-Wired Power Supply for Zebra TC22 / TC27 (Bare Device)
3PTY-PCLIP-713348	Charging Cradle with Hard-Wired Power Supply for Zebra TC22 / TC27 with Rugged Boot



Part #	Description
3PTY-PCLIP-711348	Non-Charging Cradle with Tilt-Swivel for Zebra TC22 / 27 with Rugged Boot
3PTY-PCLIP-711347	Non-Charging Cradle with Tilt-Swivel for Zebra TC22 / TC27 (Bare Device)

Gamber-Johnson  
**ZEBRA TC22/TC27 Cradles  
& Mounting Accessories**



### **ZEBRA TC22/TC27 CRADLE**

SKU# 3PTY-GJ-7160-1586

- Compatible with Zebra TC22/TC27 Handheld (Requires Zebra rugged boot)
- Cradle accommodates the Zebra TC22/TC27 hand strap.
- Adjustable cable restraint holds USB-C cord (not included) securely in place.
- Lightweight, small form factor designed to be resilient and reliable in harsh material handling and enterprise environments.
- Reduce costly damages by safely securing your device.
- Attaches to Gamber-Johnson mounting solutions using the AMPs hole pattern.



### **ZEBRA TC22/TC27 CRADLE W/ ZIRKONA MEDIUM JOINER MOUNT**

SKU# 3PTY-GJ-7170-1016

Combine the Zebra TC22/TC27 handheld computer cradle with our Zirkona Medium Joiner to achieve a reliable and secure mounting solution.

- Kit includes Zebra TC22/TC27 Cradle (SKU# 3PTY-GJ-7160-1586)
- Designed for lightweight mounting.
- Round plates offer AMPS hole pattern to mount cradle, and to attach to a Gamber-Johnson dash mount or other AMPS mounting options.
- Quick adjust handle to easily adjust your device for optimal visibility.
- Zirkona Medium Joiner provides all axes range of motion in X axis (left/right), Y axis (front/back) and Z axis (up/down)
- All metal construction (anodized aluminum) will not deform or degrade.



### **ZEBRA TC22/TC27 CRADLE W/ ZIRKONA MEDIUM JOINER + SUCTION CUP MOUNT**

SKU# 3PTY-GJ-7170-1017

Mount with confidence using the small suction cup from Zirkona. Combine the Zebra TC22/TC27 handheld computer cradle with our Zirkona medium joiner to achieve a reliable and secure mounting solution.

- Kit includes Zebra TC22/TC27 Cradle (SKU# 3PTY-GJ-7160-1586)
- Designed for lightweight mounting.
- Quick adjust handle to easily adjust your device for optimal visibility.
- Zirkona Medium Joiner provides all axes range of motion in X axis (left/right), Y axis (front/back) and Z axis (up/down)
- Small suction cup footprint of 3.5" creates a strong yet small mounting solution.
- Long handle provides ease of use when suctioning.
- Tacky surface on material helps with positioning your mount.