



VEHICLE-MOUNTED COMPUTERS

Configuration & Accessories Guide

VC80x, VC8300 8", VC8300 10"

Zebra Vehicle Mounted Computers

Product Family



Windows CE



Android

Focus on Android



VC8300 8"

VC8300 10"

Display

Half

Full

Platform

Qualcomm SD660

Qualcomm SD660

Keyboard

Integrated

External / Virtual

Features

- Unique feature set for continuous operations in freezers, cold storage and condensing environments
- Multiple mounting options,
- A 10-second quick release mount

Vehicle Mounted Computers

Configuration & Accessories Guide

- The Zebra Technologies portfolio of accessories extends the capabilities of your **VC80x** or **VC8300**, and enables you to lower the cost of ownership of your Zebra mobile computer.
- This simple step-by-step guide is designed to assist you with the selection of your accessories based on your needs and use of the computers.



VEHICLE-MOUNTED COMPUTERS

Install Illustration

STEP	ACCESSORY	SLIDE
1	Power Supplies & Cables	5-11
2	Mounts	12-15
3	Scanners	16-18
4	Keyboards	19
5	Antennas	20
6	Voice	21
7	Miscellaneous	22
8	Service Parts	23

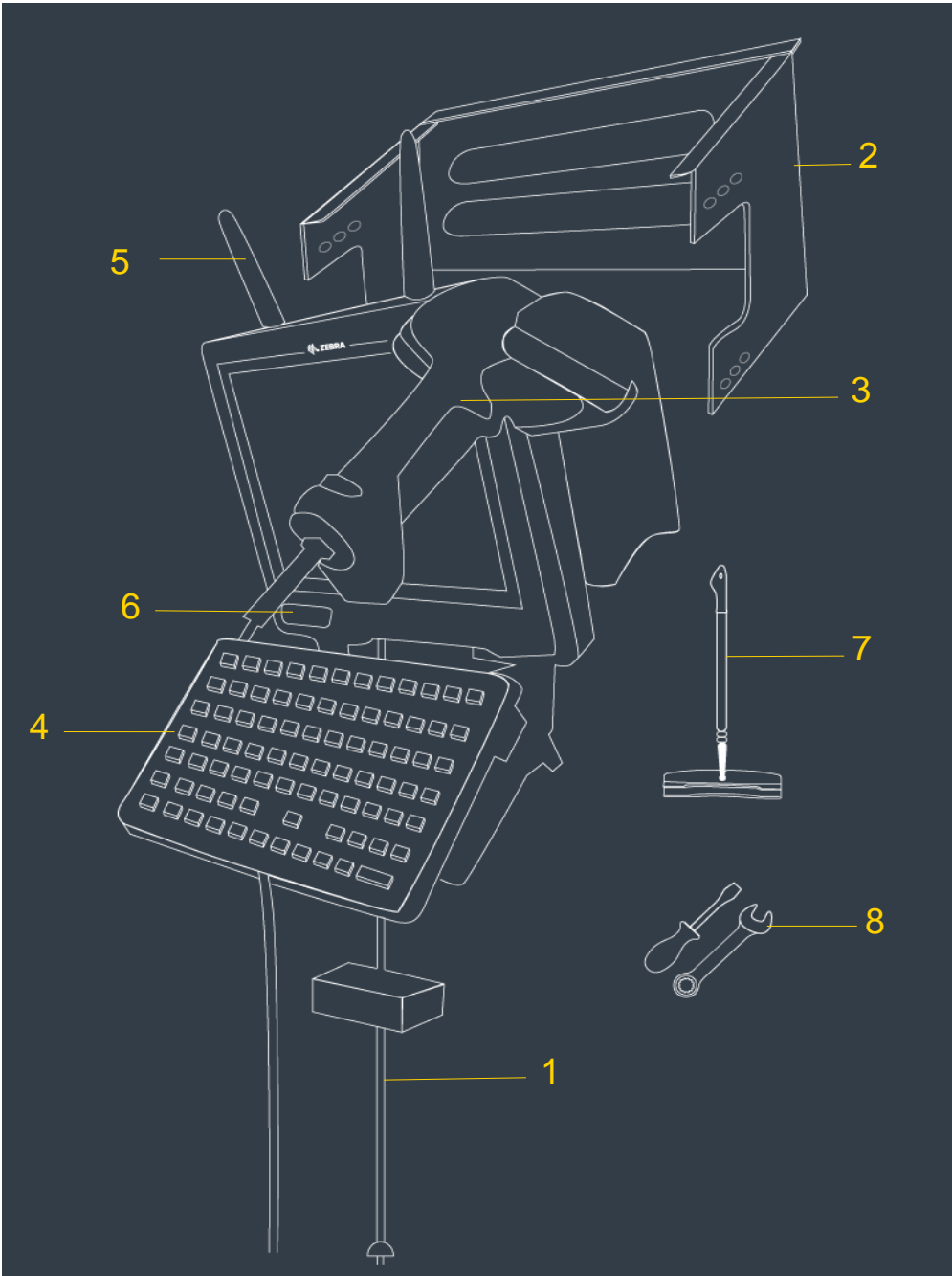

Step 1: Power Supplies and Cables

Choose from multiple installation cases

- Plug into an AC wall outlet:
Slide 6
- Plug into the Vehicle's DC power:
Slides 10-14

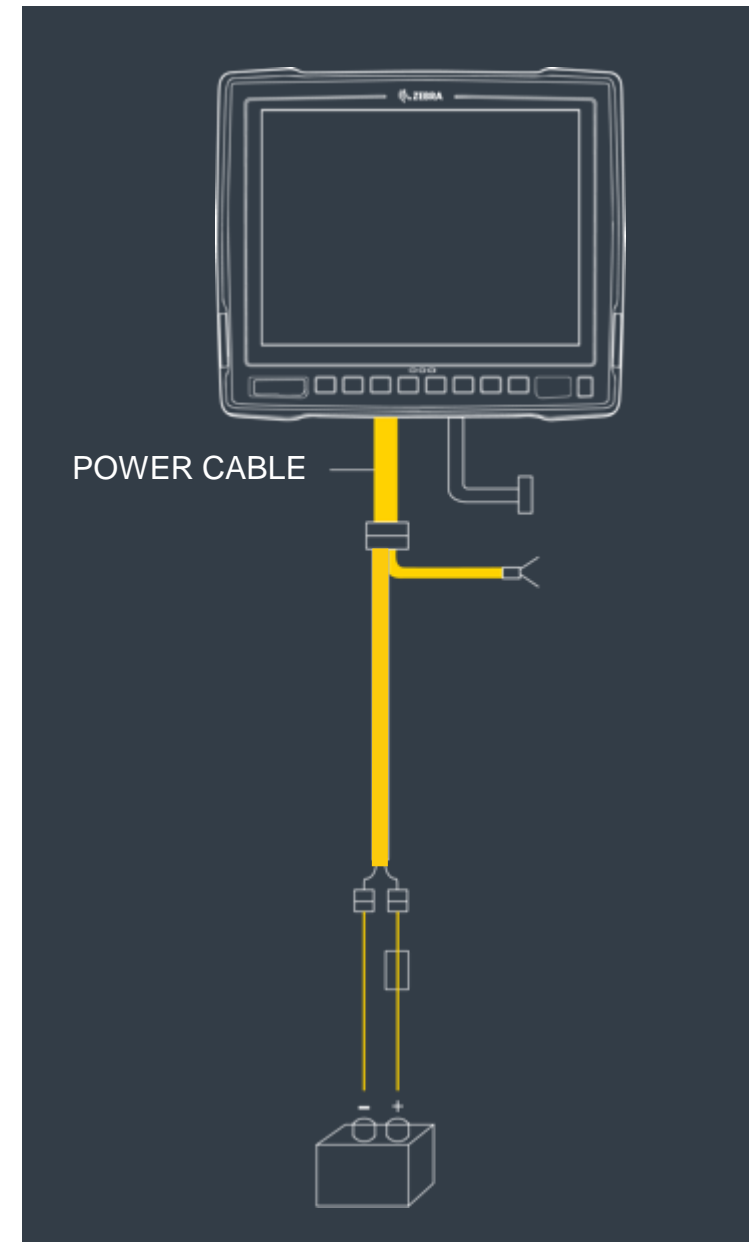

Step 1:

Power Supplies & Cables



POWERED BY PLUGGING INTO AN AC WALL OUTLET



AC POWER CABLE | ID: 23844-00-00R

US AC line cord, 7.5 feet long, grounded, three wire for the AC power supply PS1450. Associated Countries: United States.



AC POWER SUPPLY | ID: PS1450

100/240 VAC Power Supply, 12V, 6A, order AC cable separate

Step 1:

Power Supplies & Cables

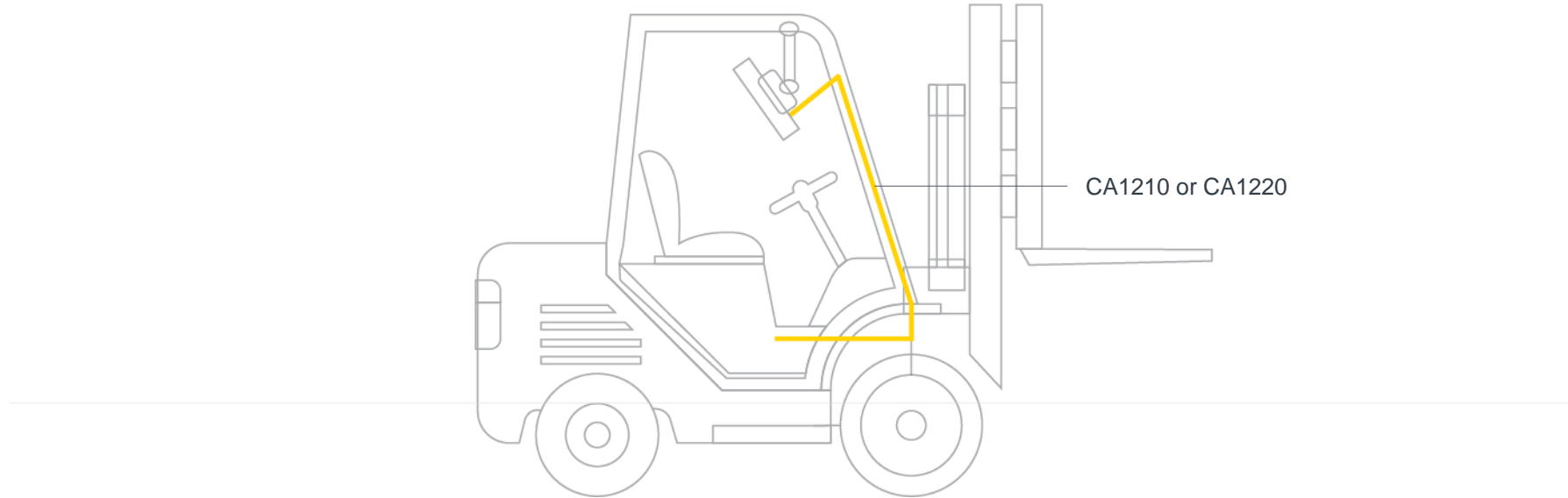

VEHICLE MOUNT (AC POWER SUPPLY IS INSIDE THE COMPUTER)

Pick one



DC POWER CABLE | ID: CA1210

Power Extension Cable, DC, 6', waterproof



DC POWER CABLE | ID: CA1220

Power Extension Cable DC, 6', waterproof - Includes ignition sense feature

Step 1:

Power Supplies & Cables

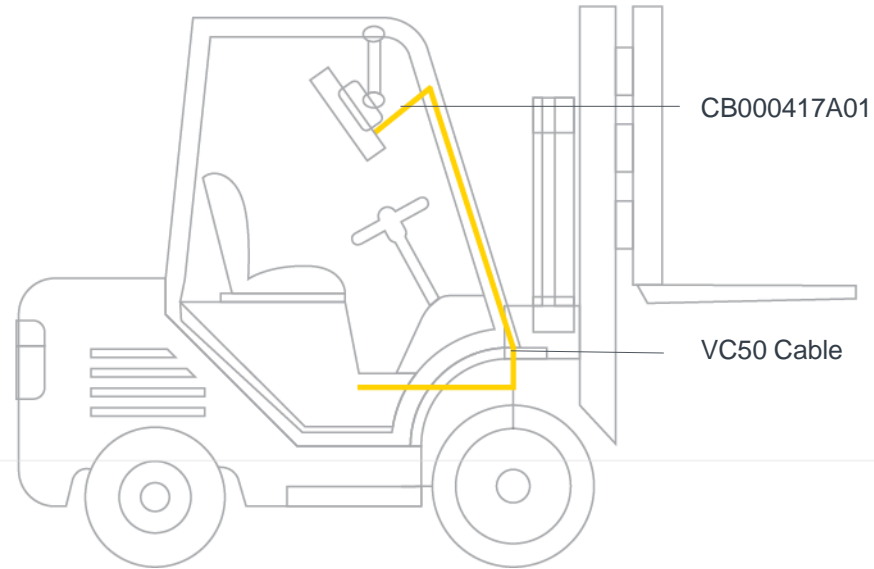

VEHICLE MOUNT (WHEN REPLACING VC50 AND REUSING THE VC50 DC POWER CABLE)



POWER ADAPTER CABLE | ID: CB000417A01
DC Power Adapter to VC50

Step 1:

Power Supplies & Cables

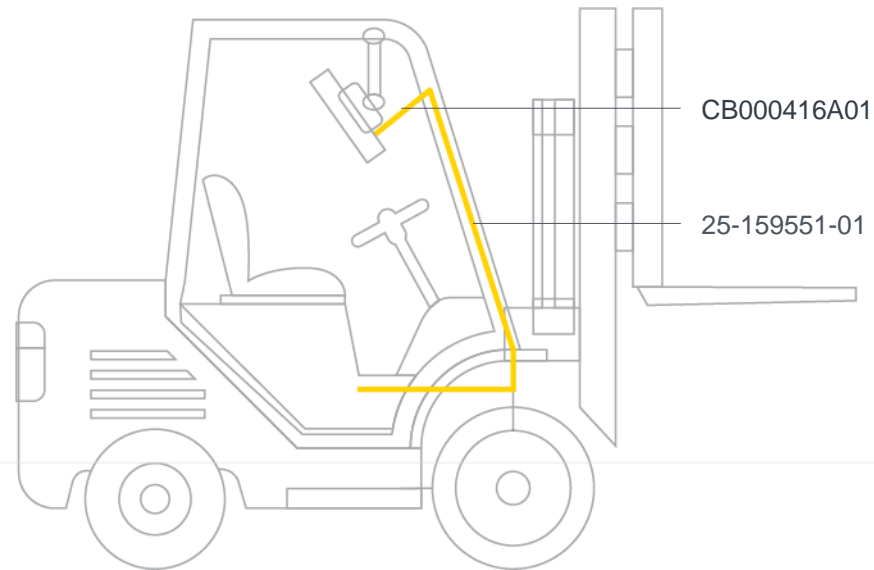

VEHICLE MOUNT (WHEN REPLACING VC70 AND REUSING THE VC70 DC POWER CABLE)





POWER ADAPTER CABLE | ID: CB000416A01
DC Power Adapter to VC70

Step 1:

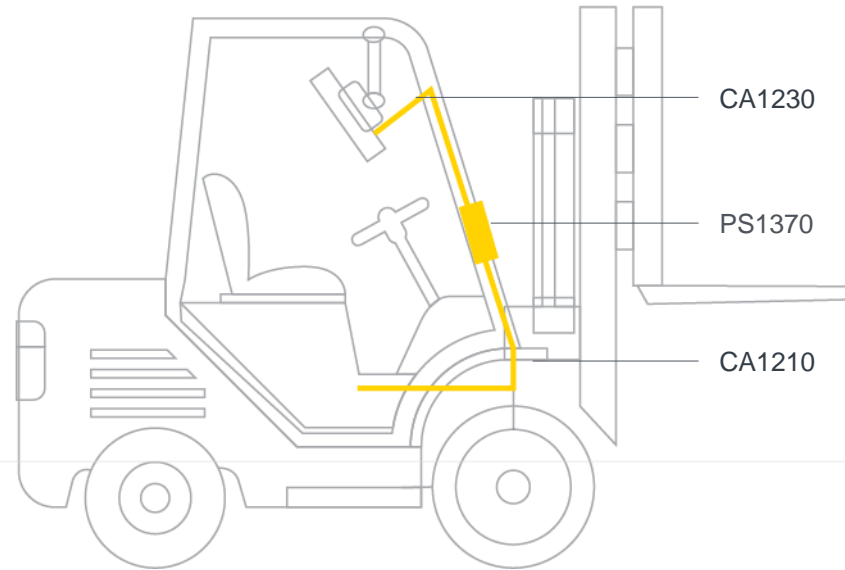
Power Supplies & Cables



VEHICLE MOUNT (WITH PRE-REGULATOR TO DECREASE VOLTAGE - FOR TRUCKS WITH BATTERIES GREATER THAN 48V)



Buy all three		DC POWER CABLE ID: CA1230 Power extension cable for pre-regulator with ignition sense
		PRE-REGULATOR ID: PS1370 Pre-Regulator, 24 - 90 VDC in, 15 VDC out, 90 W
		DC POWER CABLE ID: CA1210 Power Extension Cable, DC, 6', waterproof

Step 1:

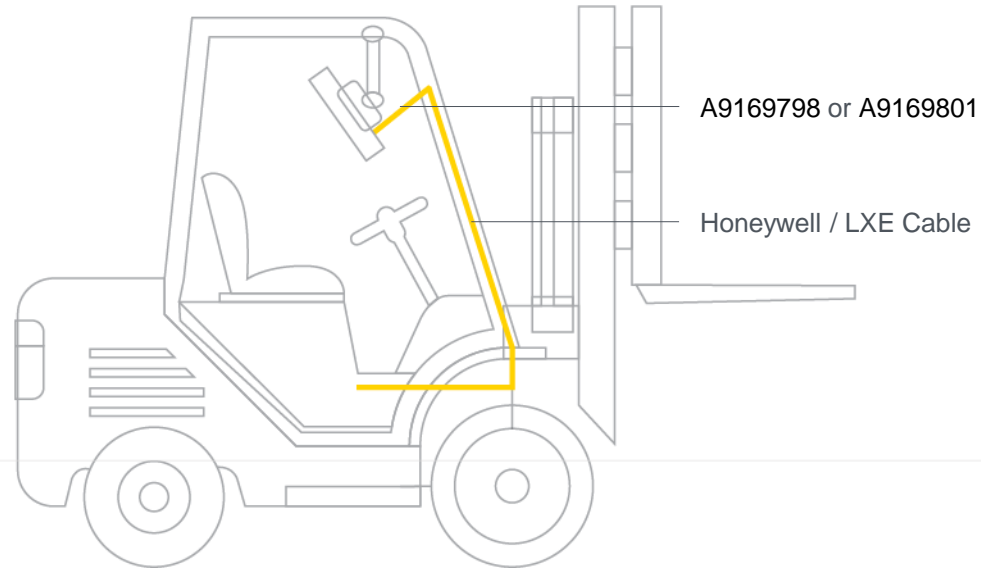
Power Supplies & Cables



VEHICLE MOUNT (WHEN REPLACING A HONEYWELL/LXE VC AND REUSING THE DC POWER CABLE)

	POWER ADAPTER CABLE ID: A9169798 Adapter CPC to LXE/Honeywell VX8, VX9, VM1, VM2 AND VM3 DC Power Extension Cable
	POWER AND SCREEN BLANKING ADAPTER CABLE ID: A9169801 Adapter CPC and serial to LXE VX8 and VX9 DC Power Extension and Screen Blanking Cable

Step 2:

Mounts

Choose the following:

- RAM Mount
- Quick-Release Mount
- U-Mount
- Adapter brackets for legacy VCs

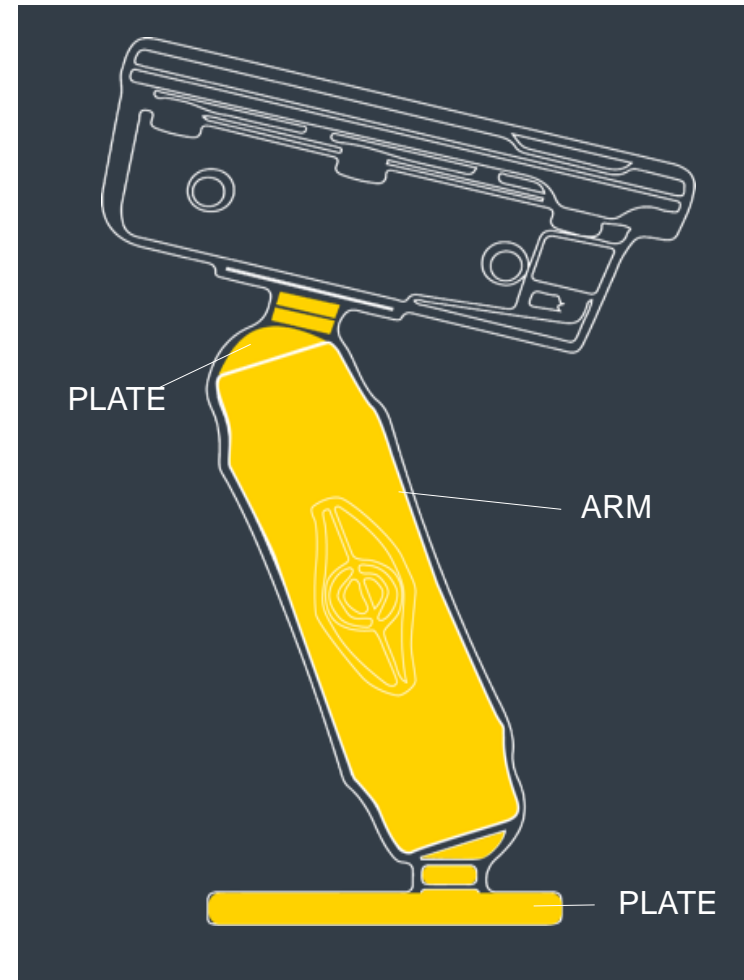

Step 2:

Mounts

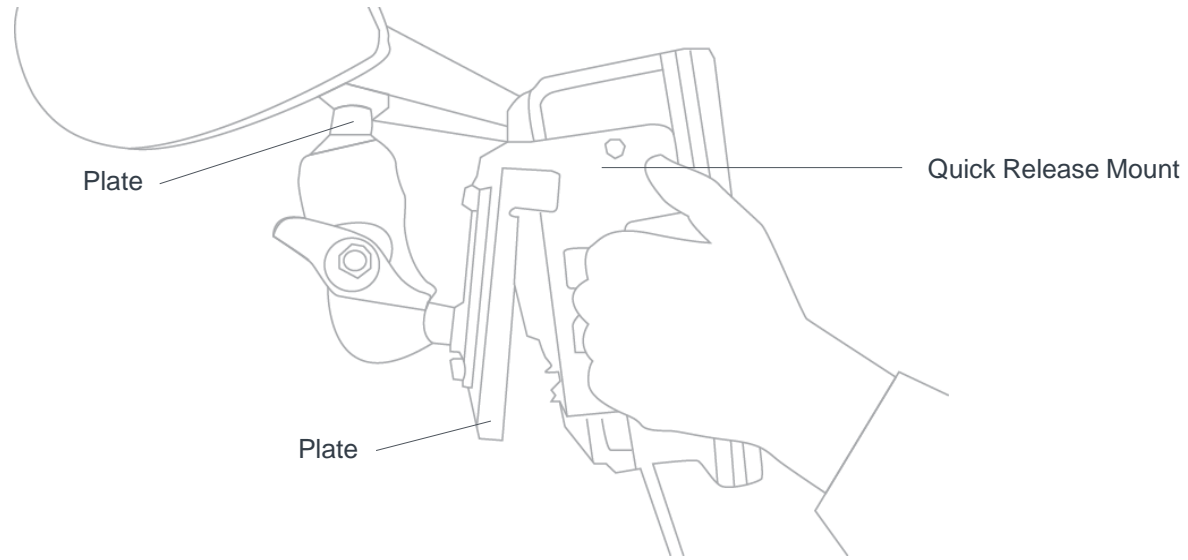

DO YOU NEED A RAM MOUNT or A QUICK RELEASE MOUNT	
	<p>QUICK RELEASE MOUNT ID: MT4200</p> <p>Quick release mount. Attaches to the side of the computer and includes Mounting Plate (MT4205) that attaches to forklift</p>
	<p>PLATE ID: MT4205</p> <p>Mounting plate for MT4200, Quick Release Mount, needed if you have one computer for multiple trucks</p>
	<p>PLATE ID: MT3501</p> <p>VESA plate (for 4" or 12" RAM arm), Can also be attached to Quick Release Mount Plate (MT4205)</p>
	<p>PLATE ID: MT4510</p> <p>RAM 2"x3" rectangular base with 2.25" rubber ball. Can be attached directly to VC80x and VC8300</p>

Step 2:

Mounts









DO YOU REPLACE A LEGACY ZEBRA OR HONEYWELL/LXE VC?

	<p>ADAPTER FOR VC50 U-MOUNT ID: MNT-VC80-ADPA1-1</p> <p>The adapter brackets for the VC50 U-Mount can be used to replace a VC50 by a VH10, VC80, VC80x or a VC8300 and reuse the existing U-Mount.</p>
	<p>U-MOUNT, WITH VC70 U-MOUNT HOLE PATTERN ID: KT-U-MOUNT-VC80-R</p> <p>The VC80 Series U-Mount is smaller than the one for the VC50 and has several mounting holes which allow drop-in replacements of VC70, and DLoG U-Mounts. It provides step less tilting of the VC and comes with the VC50 adapters.</p>
	<p>ADAPTER FOR HONEYWELL U-MOUNT ID: MNT-VC80-ADPB1-1</p> <p>The adapter brackets for the Honeywell U-Mount can be used to replace a Honeywell/LXE VC by a VH10, VC80, VC80x or a VC8300 and reuse the existing U-Mount (Honeywell part number VM1010BRKTKIT).</p>

Step 2:

Mounts



DEPENDING ON THE VEHICLE, BELOW ARE THE RAM FIXED MOUNTING OPTIONS TO THE COMPUTER AND/OR THE VEHICLE.	
	ARM ID: MT4301 RAM mount, 4" arm
	ARM ID: MT4302 RAM mount, 12" arm
	PLATE ID: MT3501 VESA plate (for 4" or 12" RAM arm), Can also be attached to Quick Release Mount Plate (MT4205)
	PLATE ID: MT3502 Round plate (for 4" or 12" RAM arm), Uses smaller footprint than MT3501 VESA Plate
	BASE ID: MT3505 Clamp base (for 4" or 12" RAM arm), 2" max. width
	BASE ID: MT3507 Clamp base (for 4" or 12" RAM arm), 3" max. width
	BASE ID: MT3509 Rail base (for 4" or 12" RAM arm), 1-1/4" to 1-7/8"
	BASE ID: MT3510 Rail base (for 4" or 12" RAM arm), 2" to 2 1/2"
	BASE ID: MT4510 RAM 2"x3" rectangular base with 2.25" rubber ball

Step 3:

Scanners

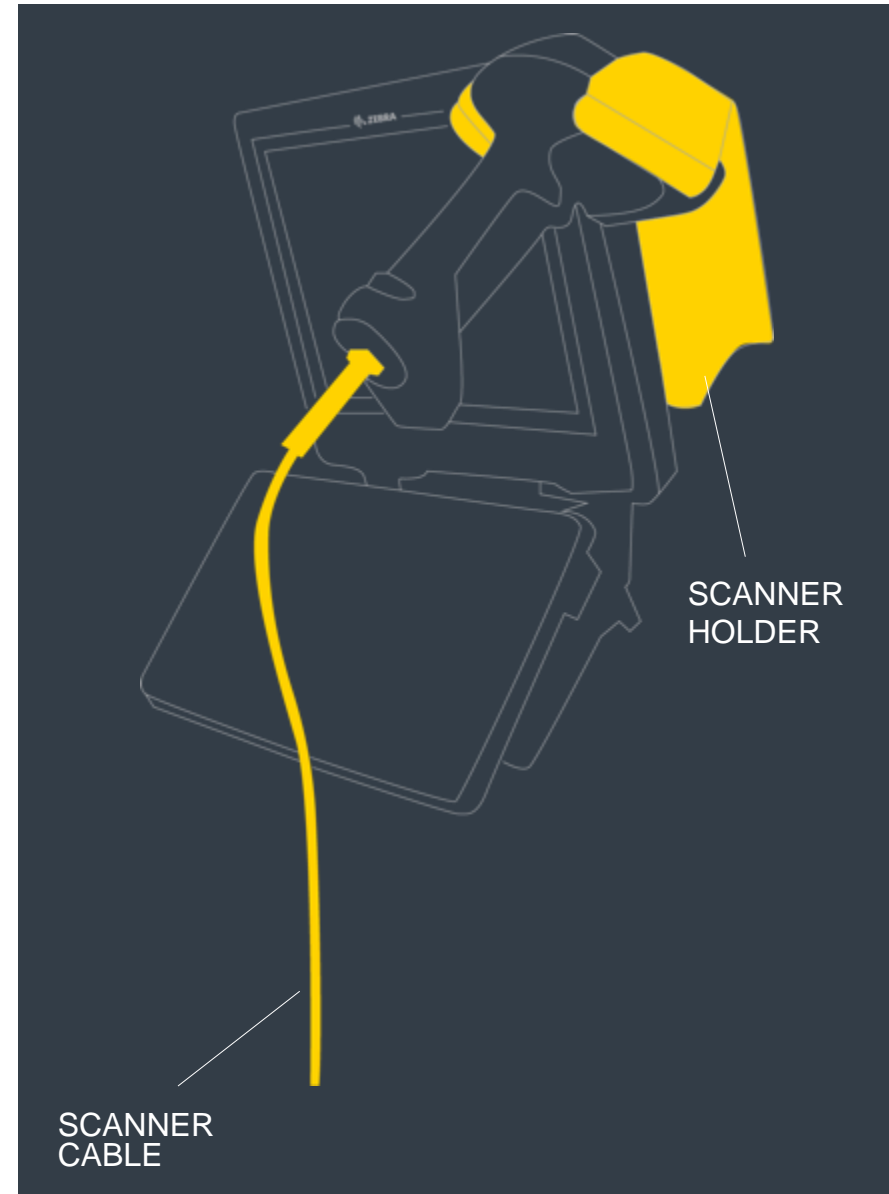

- When shopping for scanner cables, choose between coiled or straight for your scanner and between an RS232 or USB plug.
- Scanner Cables for LI/DS36XX
- Scanner cables for LS/DS 34XX/35XX
- Scanner holders





Step 3:

Scanners



	LI/DS36XXXX	SCANNER CABLES
	RS232 ID: CBA-R71-C09ZAR Cable - RS232: DB9 Female Connector, 9ft (2.8m) Coiled, Power Pin 9	
Photo Not Available	RS232 ID: CBA-RF2-C09ZAR Cable - RS232: DB9 Female Connector, 9ft (2.8m) Coiled, Power Pin 9, -30C	
	SHIELDED USB ID: CBA-U46-S07ZAR Cable - Shielded USB: Series A Connector, 7ft. (2m), Straight, BC 1.2	
	SHIELDED USB ID: CBA-U47-S15ZAR Cable - Shielded USB: Series A Connector, 15ft. (4.6m), Straight, BC 1.2	
Photo Not Available	SHIELDED USB ID: CBA-UF1-S07ZAR Cable - Shielded USB: Series A Connector, 7ft. (2m), Straight, BC 1.2, -30C	

	LS/DS 34XX/35XX	SCANNER CABLES
Photo Not Available	RS232 ID: CBA-R37-C09ZBR Cable - RS232: DB9 Female Connector, 9ft (2.8m) Coiled, Power Pin 9, with TTL Current Limit Protection	
	USB ID: CBA-U09-C15ZAR Cable - USB: Series A Connector, 15ft. (4.6m) Coiled	
	SHIELDED USB ID: CBA-U01-S07ZAR Cable - Shielded USB: Series A Connector, 7ft. (2m), Straight, BC 1.2	
Photo Not Available	SHIELDED USB ID: CBA-U10-S15ZAR Cable - Shielded USB: Series A Connector, 15ft. (4.6m), Straight, BC 1.2	

Step 3:

Scanner Holders

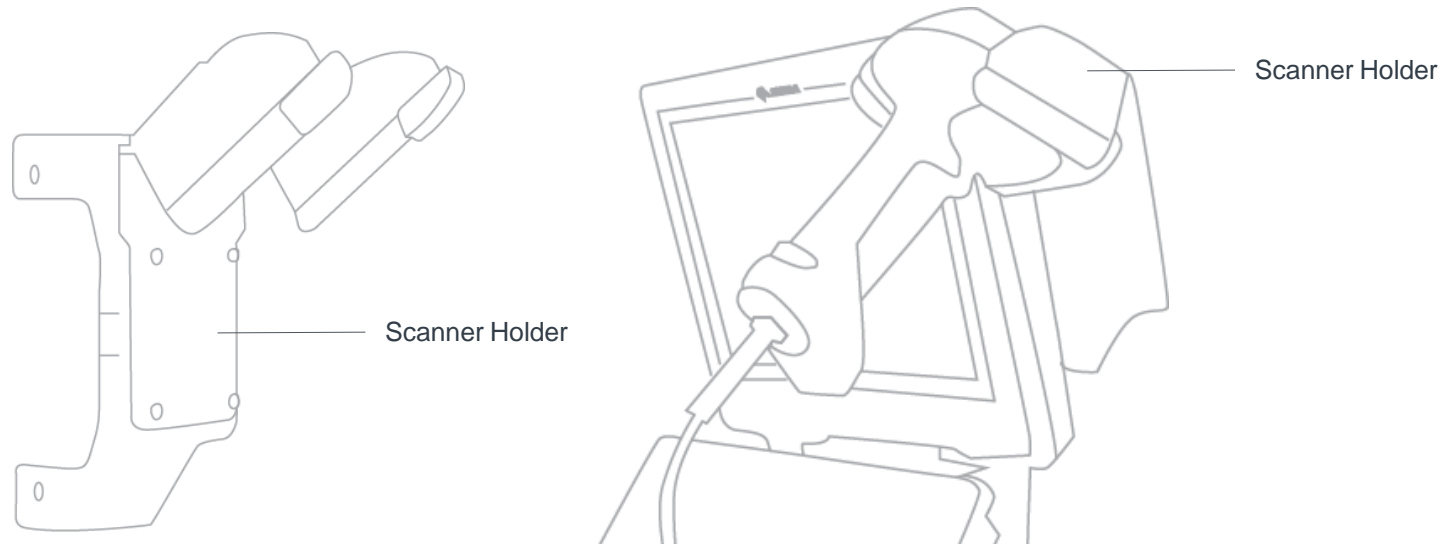







SCANNER HOLDER | ID: KT-SCANMNT-VC80-R

Side mounted holder for scanner. For LS34x8 add LS35x8

Step 4:

Keyboards, Keyboard Cables and Keyboard Mounting Options



	KEYBOARD ID: KYBD-QW-VC-01 VC USB Keyboard QWERTY
	KEYBOARD ID: KYBD-AZ-VC-01 VC USB Keyboard AZERTY
	KEYBOARD ID: KYBD-QW-VC80-S-1 USB Keyboard QWERTY with 22 cm cable for VC80/VC80x/VC8300
	KEYBOARD ID: KYBD-QW-VC80-L-1 USB Keyboard QWERTY with 300 cm cable for VC80/VC80x/VC8300
	KEYBOARD CABLE ID: CBL-VC80-KBUS1-01 22 cm VC80 Series USB cable for heated Keyboard
	KEYBOARD CABLE ID: CBL-VC80-KBUS2-01 300 cm VC80 Series USB cable for heated Keyboard
	KEYBOARD TRAY ID: KT-KYBDTRAY-VC80-R QWERTY/AZERTY Keyboard mounting tray. Includes tilting arms, knobs and screws.

Step 5:

Antennas



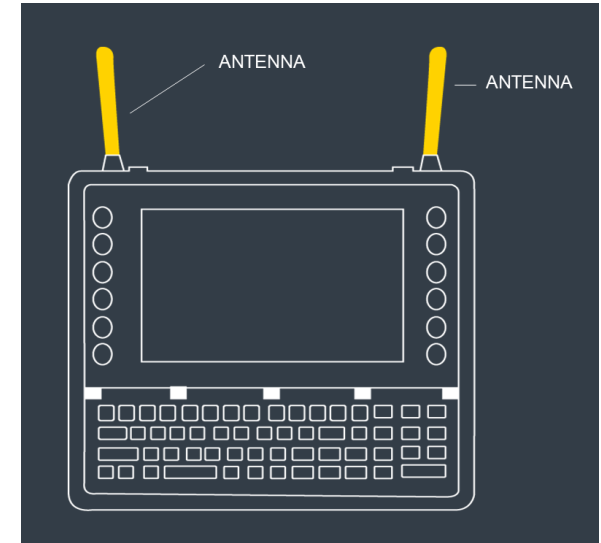

A black, stubby whip antenna with a SMA connector.	<p>ANTENNA ID: 20667-002 Whip antenna (stubby), 802.11 b/g - dipole 2 dBi reverse polarity SMA connector</p>
A dual band antenna with a magnetic mount and a coiled cable.	<p>ANTENNA ID: AN2010 Antenna, dual band, 802.11 a/b/g/n, 2 dBi, RPSMA connector, magnetic mount, 2.9m</p>
A black, cylindrical antenna with a magnetic mount.	<p>ANTENNA ID: AN2020 Antenna, 2.4 GHz, 802.11 b/g, 5 dBi, RPSMA connector, magnetic mount, 2.9m</p>
A dual band whip antenna with two thin antennas on a single base.	<p>ANTENNA ID: AN2030 Whip antenna (stubby), dual band, 802.11 a/b/g/n, 2.4GHz 2dBi, 5GHz 3.7 dBi, RPSMA connector, WiFi</p>
A gold-colored right angle SMA adapter.	<p>RIGHT ANGLE ADAPTER ID: AR1000 Right Angle SMA reverse polarity plug-jack Adapter</p>

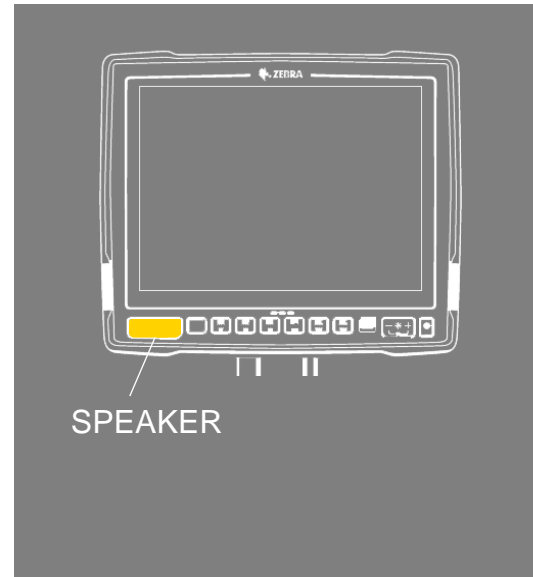
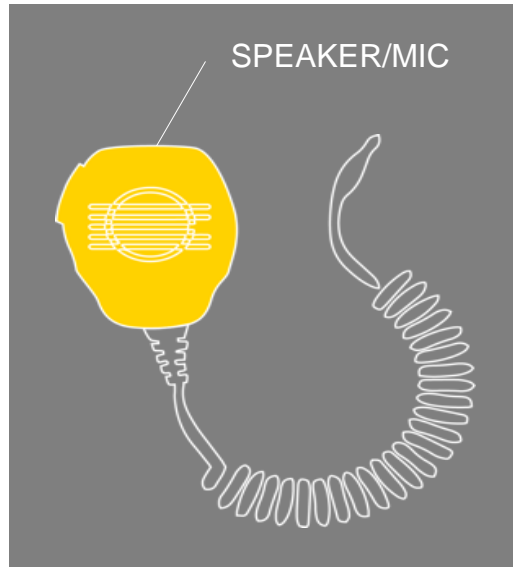

Step 6:

Voice





	<p>SPEAKER/MIC ID: M1000 Speaker/Mic with push-to-talk function</p>
------------------------------------------------------------------------------------	----------------------------------------------------------------------------------

Step 7:

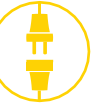
Miscellaneous



	ID: SL0001 Stylus and Stylus Holder
	ID: VA6200 8" Screen Protector Pack of 3
Photo Not Available	ID: KT-SPRTCT-VC70-05R 10" Screen Protector Pack of 5
	ID: CA1300 Screen blanking cable (DB9 to open wires)
Photo Not Available	ID: KT-AREFL-VC83-8-1 Anti Reflection Foil for VC8300 8"

Step 8:

Service Parts



SERVICE PARTS				
	ID: KT-VC80-BTRY1-01 Spare Battery	•	•	•
	ID: SPR-SMA-DC-10 SMA antenna connector dust caps, pack of 10	•	•	
Photo Not Available	ID: VC83KYBD-QW-SP-01 QWERTY Keypad Spare Elastomer		•	
Photo Not Available	ID: VC83KYBD-AZ-SP-01 AZERTY Keypad Spare Elastomer		•	
Photo Not Available	ID: KYBD-QW-VC-01 QWERTY Spare Elastomer for VC USB Keyboard			•
Photo Not Available	ID: KYBD-AZ-VC-01 AZERTY Spare Elastomer for VC USB Keyboard			•